

Aircraft Design Certification GmbH Reichensteinstr.48 69151 Neckargemünd		Bristell B23	Doc-Nr: ADxC-73-SB-029 Issue: A Date: 09.02.2023 ChangeNr.: ADxC-73-DC-092
Service Bulletin			

Bristell B23
SERVICE BULLETIN

Office of Airworthiness release
Date: Name: Kölmel Signature:

Verification Engineer
I hereby declare that the technical content of this document is correct and can be used to fulfil the obligations of the type design holder per 21.A.265(h) Date: Name: Basien Signature:

Author
Date: Name: Andre von Pinkowski Signature:

Aircraft Design Certification GmbH Reichensteinstr.48 69151 Neckargemünd		Bristell B23	Doc-Nr: ADxC-73-SB-029 Issue: A Date: 09.02.2023 ChangeNr.: ADxC-73-DC-092
Service Bulletin			

Amendments

Issue	Reason	Date
A	First Issue	09.02.2023

<p style="text-align: center;">Bristell B23</p> <p style="text-align: center;">Inspection and change of ballast attached to engine</p>

STANDARD

0 General

0.1 ATA Code

ATA 72 ENGINE – ballast attached at engine

0.2 Effectivity

All serial numbers of Bristell B23 TCDS EASA.A.642 variants with Rotax 912 engine and design change ADxC-73-DC-005/-007 installed. Airplanes with already installed design change DC-061 are exempt.

Aircraft Design Certification GmbH Reichensteinstr.48 69151 Neckargemünd		Bristell B23	Doc-Nr: ADxC-73-SB-029 Issue: A Date: 09.02.2023 ChangeNr.: ADxC-73-DC-092
Service Bulletin			

1 Planning information

1.1 Reason

Insufficient or loss of attachment bolt torque can lead to excessive wear on attachment bolt shaft and cracks of attachment lugs due to resulting pounding vibration. This, if undetected over long period of time, could lead to partial loss of attachment.

1.2 Safety Intent

No unsafe condition is identified but corrective actions are found necessary.

1.3 Configuration Description

B23 Airplanes with ballast at engine; design change ADxC-73-DC-005/-007. This change is optional and limited to B23 with Rotax 912 engine. It enables more loading flexibility within otherwise unchanged weight and balance envelope. Detection if this change is installed or not is obvious but also listed on respective appendix to Form 52 of the airplane.

1.4 Compliance

If criteria in Section 0 is met

- Service bulletin must be accomplished
- This SB could be made mandatory by an EASA AD.
 - This SB is mandatory as per EASA AD no. _____
 - Service bulletin recommended to be accomplished to prevent significant operational disruptions
 - Service bulletin to introduce improvements
 - Service bulletin for convenience or option

Compliance time is

- Initial inspection and bolt replacement within the next 50hrs of operation followed by
- Repetitive inspection during annual/100h inspection

Terminating action: Installation of Design Change ADxC-73-DC-061 and -DC-092.

1.5 Approval statement

The technical content of this document is approved under the authority of the DOA ref. EASA. 21J.411.

1.6 Concurrent publications N/A

Aircraft Design Certification GmbH Reichensteinstr.48 69151 Neckargemünd		Bristell B23	Doc-Nr: ADxC-73-SB-029 Issue: A Date: 09.02.2023 ChangeNr.: ADxC-73-DC-092
Service Bulletin			

1.7 Manpower

Approx. 0.5 hour is required to accomplish this SB for initial and repetitive action, 2h for terminating action.

1.8 Weight and Balance N/A

1.9 Electrical load data N/A

1.10 Software modification N/A

1.11 Referenced documentation

Configuration ADxC-73-DC-005/-007:

71B200200N issue C	Ballast Installation
71B200201N issue C	Ballast
M10x20 DIN933 ZN 8.8	Bolt (2ea) with d 2mm head hole drilled

Configuration after initial inspection

71B200200N issue C	Ballast Installation (with changed bolt)
71B200201N issue C	Ballast
71B200206N issue B	Ballast Bolt (2ea)
71B200208N issue B	Washer (2ea)

Configuration ADxC-73-DC-061 (and DC-092) (terminating action)

71B200200N issue D	Ballast Installation
71B200201N issue D or E	Ballast (D=reworked issue C / E=new)
71B200206N issue B	Ballast Bolt (2ea)
71B200208N issue B	Washer (2ea)

1.12 Other publications effected N/A

Aircraft Design Certification GmbH Reichensteinstr.48 69151 Neckargemünd		Bristell B23	Doc-Nr: ADxC-73-SB-029 Issue: A Date: 09.02.2023 ChangeNr.: ADxC-73-DC-092
Service Bulletin			

2 Material information

2.1 Material- cost – availability

Immediate available:

71B200206N issue B ballast bolts (2ea)

71B200208N issue B washer (2ea)

71B200201N issue D factory reworked
ballast + bolts 200€ incl. shipping cost

2.2 Company support information N/A

2.3 Material requirements per aircraft

A.) 71B200206N issue B Ballast bolt (2ea)

B.) 71B200208N issue B washer (2ea)

Additionally for terminating action:

C.) 71B200201N issue D Ballast (reworked) *OR new 71B200201N issue E Ballast*

2.4 Rework parts

Send existing ballast 71B200201N issue C to BRM for factory rework.

2.5 Special tooling N/A

Aircraft Design Certification GmbH Reichensteinstr.48 69151 Neckargemünd	 adxc aircraft design certification gmbh	Bristell B23	Doc-Nr: ADxC-73-SB-029 Issue: A Date: 09.02.2023 ChangeNr.: ADxC-73-DC-092
Service Bulletin			

3 Accomplishment/Instructions

3.1 Initial Inspection

- Remove engine cowling
- Visually inspect the surface of the ballast for cracks occurrence in the area of attachment to the engine and/or signs of a loose connection indicated by the appearance of grey-black dust, see Figure 4 in Appendix.
- Remove safety wire at ballast attachment bolts
- Remove bolts and ballast
- Discard bolts
- If grey dust was found: Visual inspect engine threaded hole: no thread damage is allowed. In case of thread damage contact BRM, installation of helicoil might be needed.
- Visually inspect ballast for cracks: no cracks allowed, see Figure 2
- Visual inspect ballast attachment lug holes – no elongation or wear allowed. Nominal diameter of hole 10.0mm tolerance +0.015/-0.0
- If cracks or hole wear is found sent to BRM for repair/upgrade (immediate terminating action).
- If ballast is free of cracks or hole wear reinstall ballast (mind correct orientation) using 71B200206N issue B Ballast bolt (2ea) and 71B200208N issue B washer (2ea)
- Before installation, check 71B200206N issue B Ballast bolt for unthreaded shaft length of 6 mm
- Before installation, check 71B200208N issue B washer for thickness of 3 mm
- Torque attachment bolts to 26-35Nm
- Perform engine run up according AFM, perform minimum 5 rapid RPM changes idle to max RPM. Shut down aircraft according AFM.
- Recheck torque of bolts PN 71B200206N issue A after cool down.
- Reapply safety wire.
- Reinstall cowling.

Make appropriate entry of accomplishment in aircraft logbook and life cycle documentation

3.2 Repetitive inspection

- Remove engine cowling
- Visually inspect ballast for cracks: no cracks allowed, see Figure 2
- IF cracks are found sent to BRM for repair/upgrade (immediate terminating action).
- IF ballast is free of cracks: Reinstall cowling.

Aircraft Design Certification GmbH Reichensteinstr.48 69151 Neckargemünd		Bristell B23	Doc-Nr: ADxC-73-SB-029 Issue: A Date: 09.02.2023 ChangeNr.: ADxC-73-DC-092
Service Bulletin			

Make appropriate entry of accomplishment in aircraft logbook and life cycle documentation

3.3 Terminating action

- Remove engine cowling
- Remove safety wire at ballast attachment bolts
- Install factory reworked ballast PN 71B200201N issue D (*OR new 71B200201N issue E Ballast*) using bolts PN 71B200206N issue B and 71B200208N issue B washer (2ea) according installation drawing 71B200200N issue D; Torque attachment bolts to 26-32 Nm
- Perform engine run up according AFM, perform minimum 5 rapid RPM changes idle to max RPM. Shut down aircraft according AFM.
- Recheck torque of bolts PN 71B200206N issue B after cool down.
- Reapply safety wire.
- Reinstall cowling.

Make appropriate entry of accomplishment of terminating action in aircraft logbook and life cycle documentation.

Service Bulletin

4 Appendix

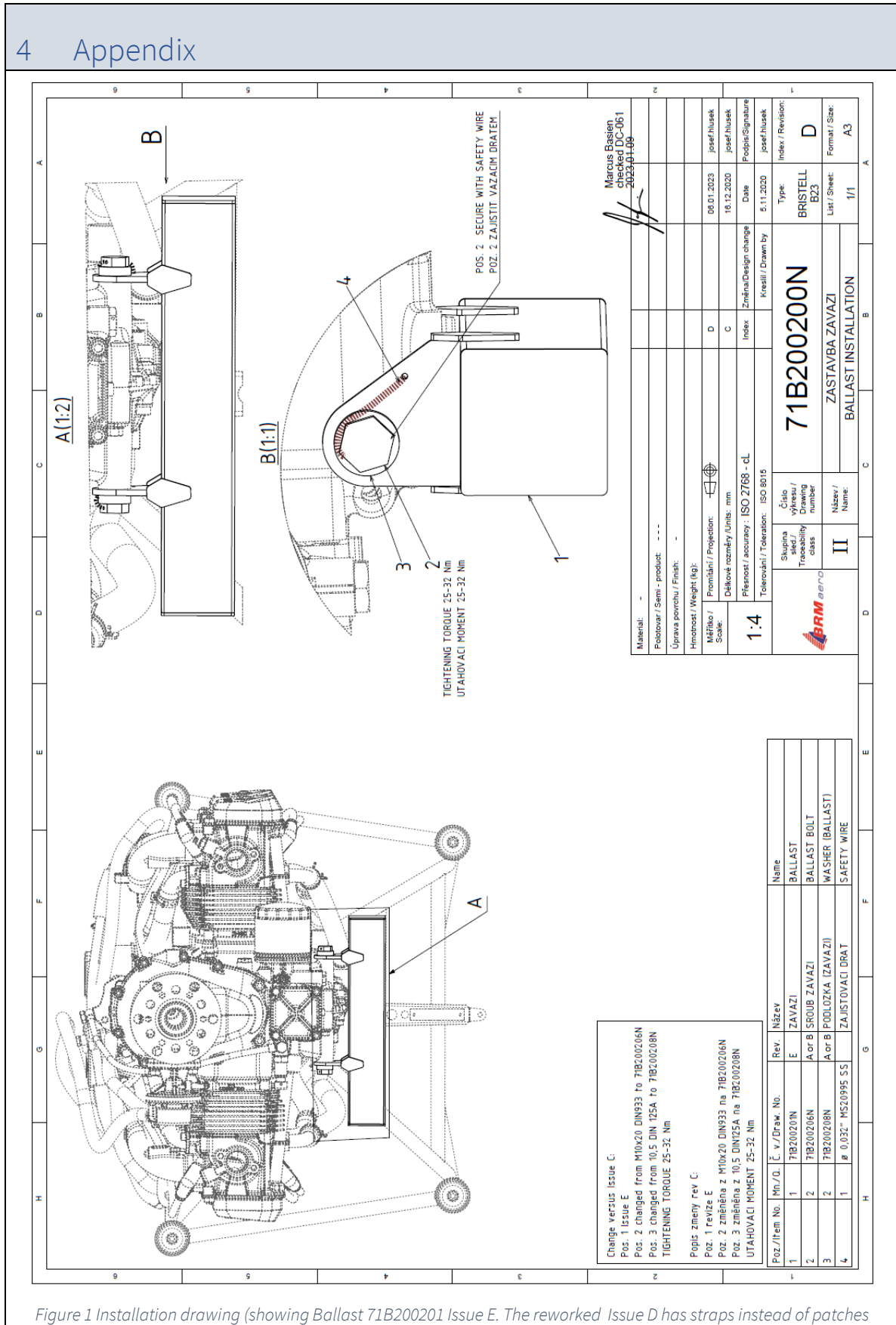

Figure 1 Installation drawing (showing Ballast 71B200201 Issue E. The reworked Issue D has straps instead of patches

Service Bulletin

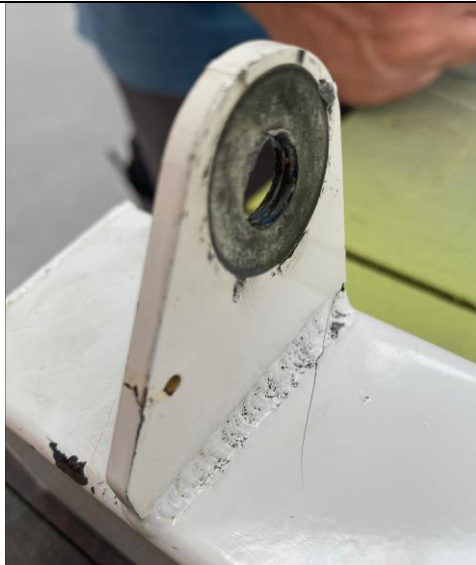

Figure 2 Cracks found on ballast lug



Figure 3 Bolts showing wear on thread

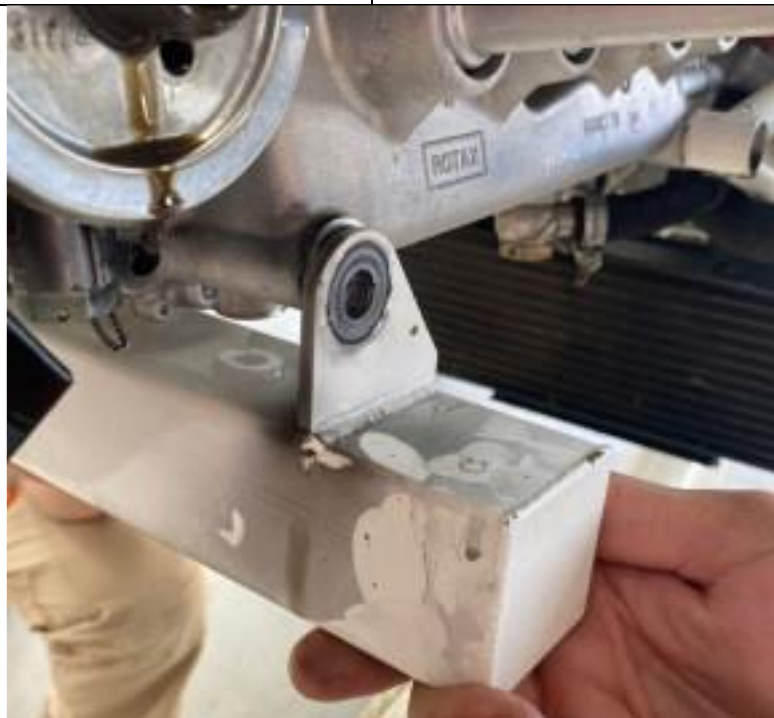

Figure 4 Grey dust on ballast indicating wear on bolt/thread/attachment)